



Safety Rules (Attention):

- Do not install the LED Downlights near flammable liquid, materials, or surfaces.
- Do not subject the LED Downlights to excess weight.
- Avoid looking directly into the LED light beam at close range.
- Clean, when needed, the front transparent cover with a dry cloth. Remove any dirt only with water and alcohol-free cleaning products.
- Operation in general ambient temperature up to 35°C.
- ELECTRON S.A. is not responsible for any damage or injury caused by incorrect or improper use of the product.

Safety Rules (Attention):

- Before installation or maintenance, make sure electricity is switched off at the mains.
- Install and operate in places where there is sufficient airflow to keep the module to acceptable temperature levels.
- Cut correct size hole in ceiling given the dimensions below.
- Make sure the correct driver is used.
- Make sure the driver lies adjacent to the fitting.
- Installation only by a qualified electrician.

Indicative Dimensions:

6.4W

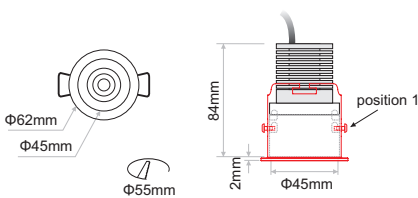

8.8W

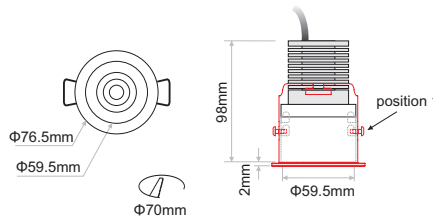

12.8W & 17W

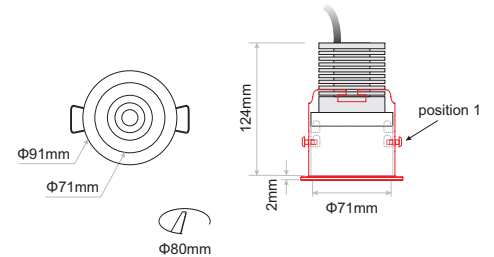

8.7 & 12.6W Adjustable

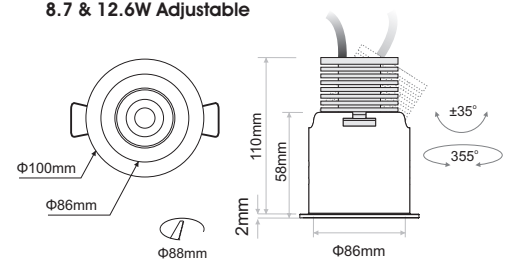

Note:

Please note that certain dimensions mentioned in this manual are subject to change without prior notice. Our products are continually evolving to improve performance and meet industry standards. It is essential to check for updates regularly to ensure that you have the latest information.

1

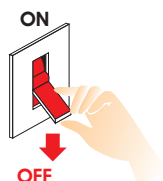

Attention

Before any maintenance switch off the main power.

2

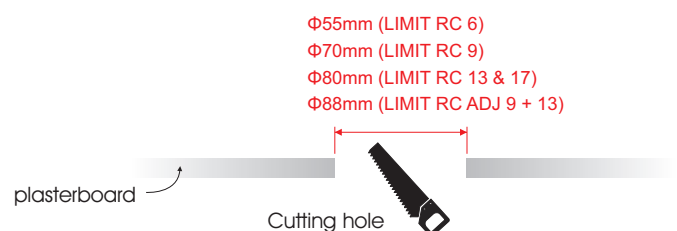

3 Place the bolt marked as red on the desired position.



1st position:

The luminaire can be mounted flashed or extruded from the ceiling.

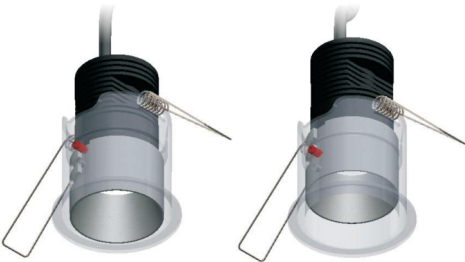

2nd position:

The luminaire can be mounted flashed or deep recessed.

4 Install the recessed accessory on the ceiling following the step as illustrated below:

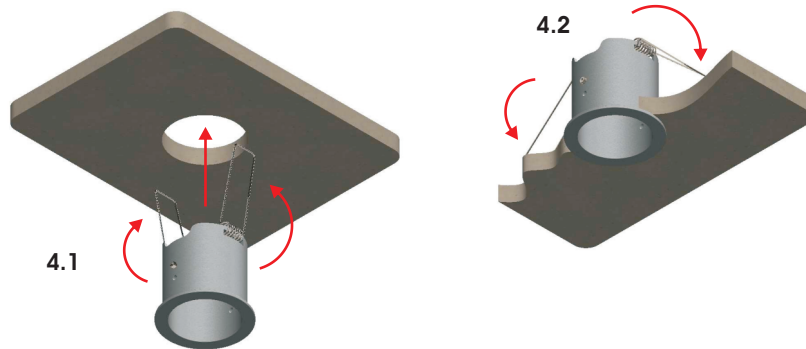

5 Insert the fixture through the installed base and turn it clockwise to lock it in desired position.



6 Insert the fixture through the installed base and turn it clockwise to lock it in desired position.

